

# LAZER

H I G H P E R F O R M A N C E L I G H T I N G



## **FORD TRANSIT CUSTOM (2018+) BUMPER BEAM INSTALL FOR TRIPLE-R 1250**

---

**FITTING INSTRUCTIONS**

**ANLEITUNG**

**INSTRUCTIONS**

**INSTRUCCIONES**

## TECHNICAL SUPPORT

aaron@lazerlamps.com / sales@lazerlamps.com  
 +44 (0)1992 945601 / +44 (0)1992 677374

## WHAT'S REQUIRED

- FORD TRANSIT CUSTOM 2018+ MOUNTING KIT
- TRIPLE-R 1250 STANDARD, SMARTVIEW or ELITE WITH I-LBA
- ONE-LAMP HARNESS KIT (INCLUDED WITH SMARTVIEW & ELITE I-LBA)
- DASHBOARD CONTROLLER (REQUIRED FOR SMARTVIEW ONLY)
- CANM8 CANDUO (REQUIRED FOR SMARTVIEW ONLY)

## DIFFICULTY LEVEL



## TOOLS REQUIRED



DRILL BIT  
5MM

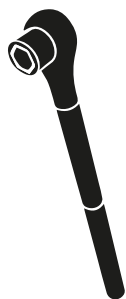

METRIC  
SOCKET SET



WIRE STRIPPERS  
AND RATCHET CRIMPERS



WIRE CUTTERS



RIVET GUN



ALLEN KEY  
SIZE: 5

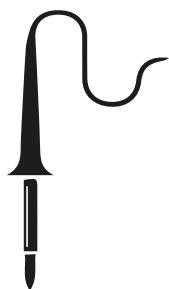

SOLDERING  
IRON



T25 / T30 TORX  
SCREWDRIVERS



PLASTIC  
TRIM TOOLS



ANGLE  
GRINDER

## PRE-INSTALLATION CHECKS

1. Ensure battery is disconnected.

## BUMPER REMOVAL



### STEP 1

Remove the x2 T30 screws on each headlight.



### STEP 2

Unplug the headlights on both sides.



### STEP 3

Lift out both headlights.

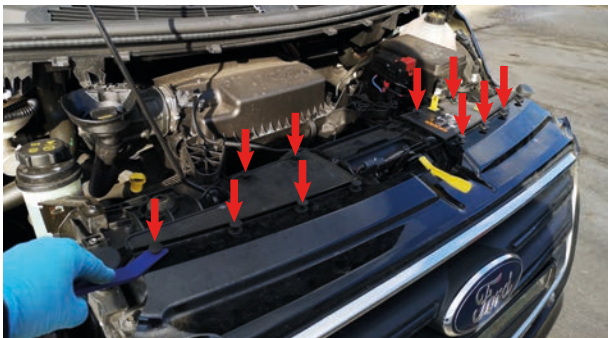

### STEP 4

Remove x12 plastic push rivets.



### STEP 5

Remove number plate.





### STEP 6

Remove the x2 13mm bolts behind number plate.



### STEP 7

Remove x4 T30 screws from under bumper.



### STEP 8

Remove the x2 T25 screws on the inside of both wheel arches.



### STEP 9

Unplug bumper loom connector located behind washer reservoir.

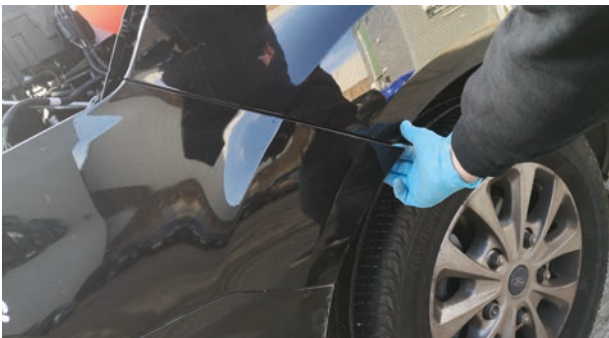

### STEP 10

Gently pull both corners of the bumper out.



**STEP 11**

Unclip retaining clip on both sides under headlight.



**STEP 12**



Pull top centre of bumper up and unclip the retaining clips on both sides of the vehicle.

**MOUNTING YOUR TRIPLE-R 1250**

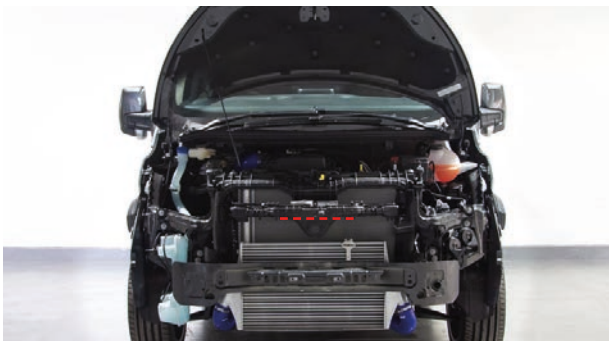

**STEP 1**

Remove part of the radiator support bar as shown as you will need this space for the light to fit in place.



**STEP 2**



Fix each Centre Mount to the Bumper Beam brackets as shown using the supplied: bolt, 3x nuts, spring and penny washer (centrally on the middle mounting slot).



**STEP 3**



The rotating feature will need to be removed and turned round so that the M5 grub screws are showing at the front of the mount instead of behind.

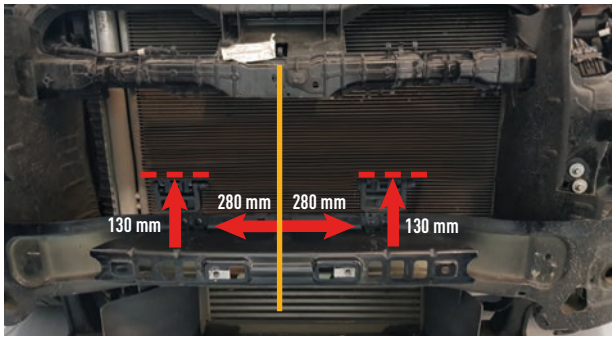

#### STEP 4

Mark where you will mount the Bumper Beam Brackets to the bumper beam as per the measurements shown.



#### STEP 5

Drill the 5mm pilot holes for the rivets for the Bumper Beam Brackets (2 rivets per bumper beam bracket).



#### STEP 6

Using a rivet gun, rivet the Bumper Beam Brackets into place.



#### STEP 7

The Triple-R 1250 Smartivew can now slide onto the Centre Mounts, once in place, tighten the M5 grub screws on the Centre Mounts.



#### STEP 8



Assemble Stay bar and place in lamp channel to mark where you will bend the Stay Bar in order to mount it to a secure surface.



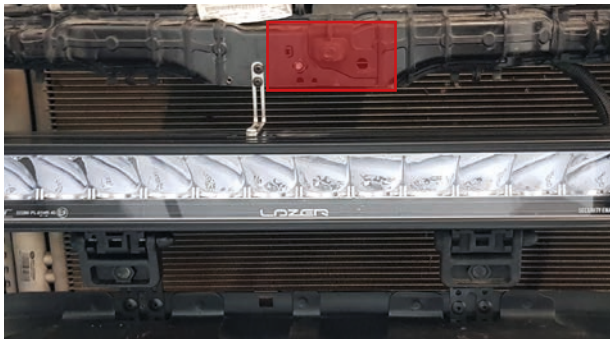

**STEP 9**

Bend the Stay Bar where you have marked and secure to the vehicle using a self tapping screw and to the lamp using the M5 grub screws included in the kit.

Be sure to avoid the Red highlighted area as this is where a Air-Bag sensor is located.

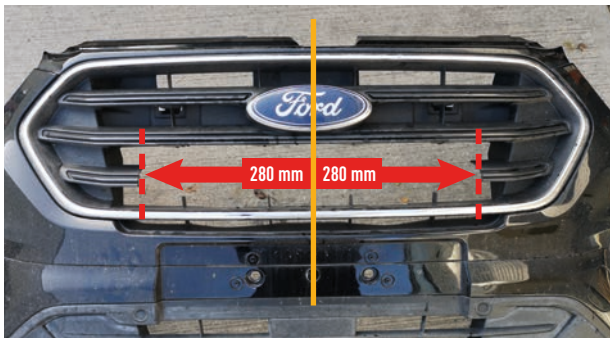

**STEP 10**

Prepare the grille ready to be re-fitted to the vehicle.

Cut the main grille underneath the ford badge as per the measurements shown.

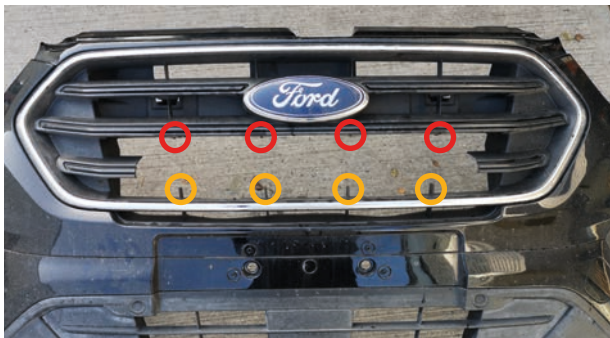

**STEP 10.1**

**WIRING**

Please refer to Lamp instructions when connecting a Triple-R 1250 Elite with I-LBA.  
Steps 4 onwards is for Triple-R 1250 Smartview only.



**STEP 1**

Live (red wire) should be taken from the 10mm stud next to engine fusebox.



**STEP 2**

Ground should be taken from 10mm bolt in front of the engine fusebox.

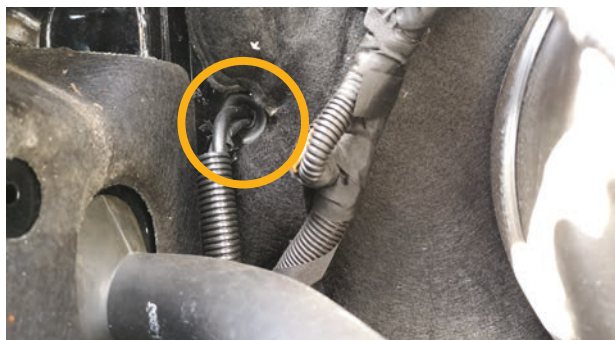

**STEP 3**

Switch can be fed through the cab through the bulkhead, alternatively the light can be connected directly to the highbeam (Grey wire at the back of the headlight)

Cable entry for the vehicle is located on the far right of the bulkhead. You will need to feed the live and earth cable as well as the lamp cables through here.

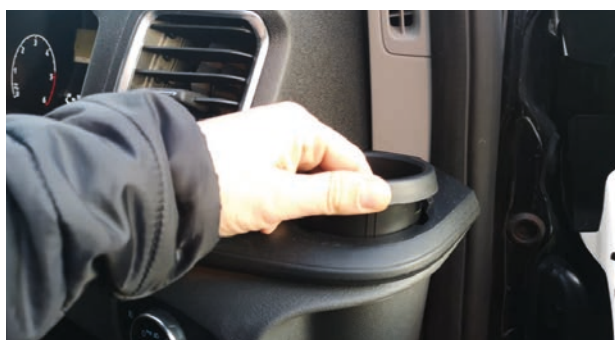

**STEP 4**

Remove the right hand cupholder.



**STEP 5**

Undo the x2 T25 torx screws below the cup holder.



**STEP 6**

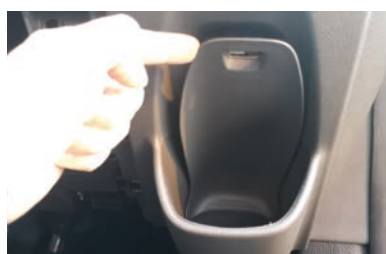

Remove the lower cover and unscrew the T25 torx behind.

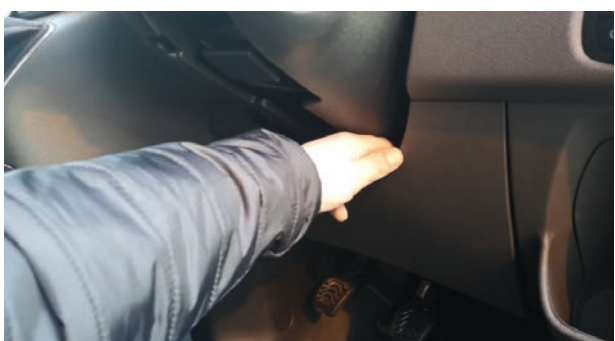

**STEP 7**

Remove the panel beneath the steering wheel.



**STEP 8**

Pull the trim forward and unplug the light switch, then completely remove panel. Remove light switch and plug back in to stop noise.

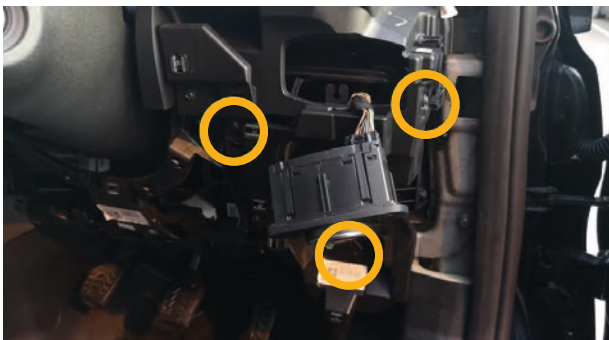
**STEP 9**

Unscrew the 3x T25 screws holding in the right hand panel and remove to reveal the interior fusebox.

**STEP 10**

Live, earth and Smartview lamp wires can be brought through to fusebox area.

**STEP 11**

Ignition feed for ATU can be taken from the yellow/grey wire in the black plug by the door.

**STEP 12**

Plug in the ATU as per wiring diagram included with Triple-R Smartview Quick-start guide.

Run the cable for the Dashboard Controller (recommended location shown).



### STEP 13

Red wire in the black plug by the door is 12V live for CanM8 T30 bolt below can be used as ground/earth for CanM8.



### STEP 14

Locate the OBD plug on the right hand side, undo the 2x 8mm nuts to get access for the canbus wiring to install the CanM8.

## CAN-M8 DUO INTERFACE INFORMATION

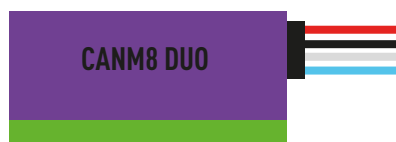

**RED** > 12V LIVE RED WIRE  
**BLACK** > GROUND/EARTH T30 BOLT  
**WHITE** > OBD PIN 3 (GREY/ORANGE)  
**BLUE** > OBD PIN 11 (PURPLE/ORANGE)

## INSTALLATION CHECKS

1. Ensure battery is re-connected properly.
2. Test light bar is working fully before re-assembling vehicle.

**LAZER**  
 HIGH PERFORMANCE LIGHTING

**Thank you for choosing a Lazer Lamps product.**  
 Vielen Dank dafür, dass Sie sich für ein Produkt von Lazer Lamps entschieden haben.  
 Merci pour choisir un produit de Lazer Lamps.  
 Gracias por la seleccion de productos de Lazer Lamps.