

LAZER

HIGH PERFORMANCE LIGHTING

TRIPLE-R 1250 SMARTVIEW



BOASTING INNOVATIVE FUNCTIONALITY THAT PROVIDES FOR ENHANCED SAFETY, COUPLED WITH LIGHTING PERFORMANCE AT THE PEAK OF LED TECHNOLOGY, THE TRIPLE-R SMARTVIEW IS THE PINNACLE OF AUTOMOTIVE LIGHTING TECHNOLOGY.

Integrated into your vehicle's electrical system via an Anti-Theft Module boasting 'Plug & Play' connectivity, the Smartview allows operation of 5 different lighting modes. Operated by a touchscreen 'Dashboard Controller', each mode delivers real-world benefits suited to different road and off-road applications and conditions, and each benefitting from the latest and most efficient LED technology to deliver unrivalled lighting performance like no other.



HIGH PERFORMANCE LED DRIVING LAMPS

TRIPLE-R SMARTVIEW FUNCTIONALITY



STANDARD
LOW
BEAM



STANDARD
HIGH
BEAM

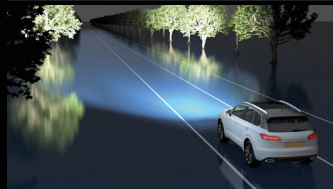

**E9 E-MARK
COMPLIANT MODE**
Enables the customer to operate the lamp in compliance with EU road-legal requirements.



**E-BOOST
MODE**
Increases the intensity of light for maximum visibility. Off-Road use only.

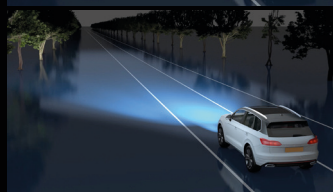

**NEAR-VIEW
MODE**
Provides superior levels of short-range illumination, ideal in more extreme weather conditions such as fog and snow.

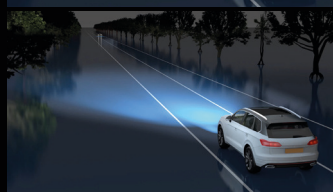

**DYNAMIC
DIP**
Delivers a smoother transition between high and low beam allowing time for the driver's eyes to adjust to lower light levels.



SPEED ADAPT MODE
Beam pattern adjusts depending on the speed of the vehicle between 30mph/50kph - 50mph/80kph. Requires CanM8 Duo Interface.



TRIPLE-R

TRIPLE-R 1250 SMARTVIEW

- Capable of delivering five different lighting functions
- Road-legal when operated in E-mark compliant mode
- Lighting functions operated by a Dashboard Controller (sold separately)
- 'Plug & play' connectivity via an Anti-Theft Unit specific to each lamp
- Security Enabled – lamp will not operate if removed from the vehicle without the anti-theft unit



TRIPLE-R 1250 SMARTVIEW – BOOST FUNCTION ENGAGED*

GENERATED FROM ESI LAMP PHOTOMETRIC TEST DATA ON ROAD MEASUREMENT DATA

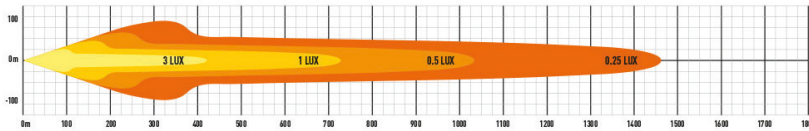

*BOOST FUNCTION IS ENGAGED WHEN SELECTED VIA THE DASHBOARD CONTROLLER.

TRIPLE-R 1250 SMARTVIEW – E-MARK COMPLIANT MODE

GENERATED FROM ESI LAMP PHOTOMETRIC TEST DATA ON ROAD MEASUREMENT DATA

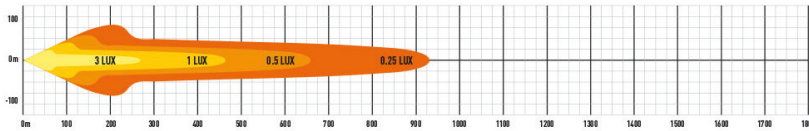

Horizontal: 21°
Vertical: 9°
(2% of peak)

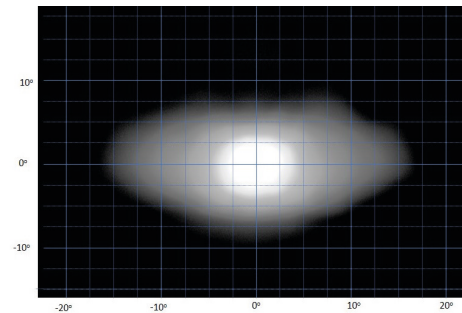

TECHNICAL SPECIFICATIONS



| | |
|------------------------|-------------|
| E-MARK REF | 45 |
| VOLTAGE RANGE | 9V - 32V |
| RAW LUMENS | 12,170 |
| BEAM PATTERN | VARIOUS |
| BEAM DISTANCE (0.25LX) | 1463m |
| # HIGH POWER LEDS | 12 |
| POWER CONSUMPTION | 105 Watts |
| CURRENT DRAW† | 7.3 Amps |
| LED LIFE | 50,000 Hrs* |
| WEIGHT | 1940g |

* LED Manufacturers Specifications †At 14.4 Volts

MOUNTING OPTIONS:



(Side Bracket kit sold separately)

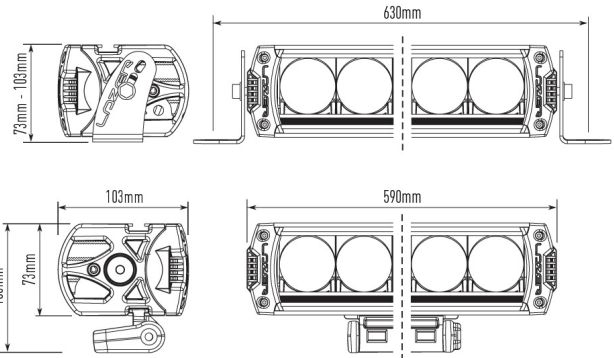

LAZER LAMPS LTD

Units 1+2, Harlow Mill Business Centre, Riverway, Harlow, Essex. CM20 2FD. UK

Tel: +44(0)1992 677374

Email: sales@lazerlamps.com

www.lazerlamps.com

LAZER

HIGH PERFORMANCE LIGHTING

